



## Installation instructions

 Refer to installation use and maintenance manual for more information.



## 2 phase bipolar stepper drive technical data:

- Power supply: 18 ÷ 100 Vac
- Phase current: up to 8.5 Arms (12 Apeak) **(Note 1)** 
- Chopper frequency: ultrasonic 40KHz
- Stepless Control Technology (65536 position per turn)
- Protections against: over current, over/under voltage, overheating, short circuit between motor phase-to-phase and phase-to-ground
- Modbus or Canbus communication interfaces
- Service SCI interface for programming and real time debugging
- 4 digital inputs (opto-coupled)
- 2 digital outputs (opto-coupled)
- 2 analog inputs (NOT isolated)
- Dimensions: 154.4 x 123.5 x 46 mm (without connectors)
- Protection degree: IP20
- Pollution degree: 2
- Category C3 following standard EN 61800-3
- Working temperature 5°C ÷ 40°C; Storage temperature -25°C ÷ 55°C
- Humidity: 5% ÷ 85% not condensing

**TITANIO**  
VECTOR - STEPPER - DRIVES

error less  
servo efficient  
**else**  
technology  
by Ever Electronics

**CANopen**  
DS402



 **Note 1:** Evaluate carefully the power required by the load in the various applications, so that the average current absorbed by the supply not exceed 6 Arms.

## Mechanical data

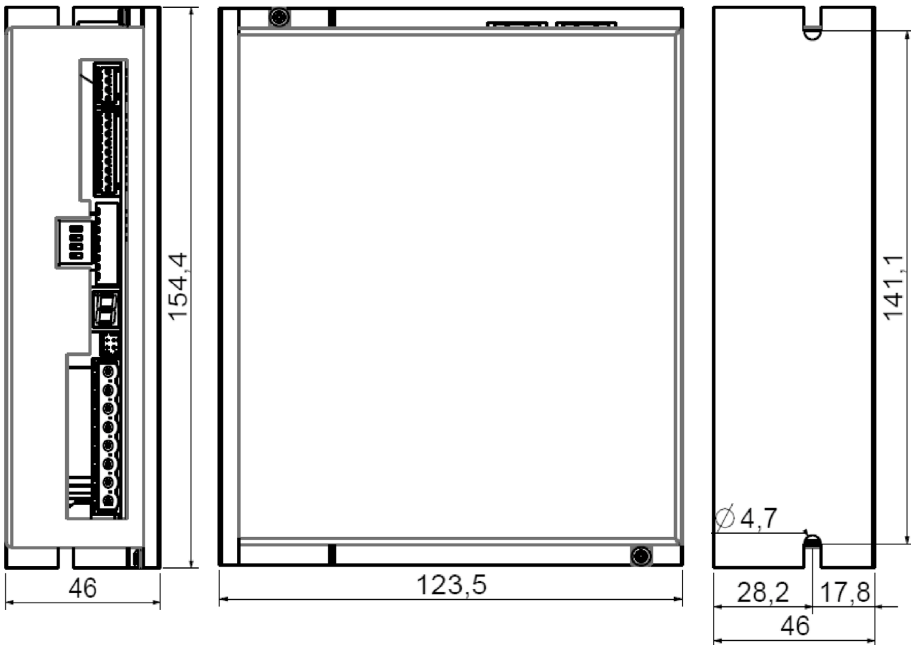

# Models

## MODELS IN THIS SHORT

System Code	Fieldbus	Supply
SW4 <b>A</b> 4085 <b>C</b> 261-00	CanOpen	AC
SW4 <b>A</b> 4085 <b>M</b> 261-00	ModBus	AC

# System connections

Connectors:

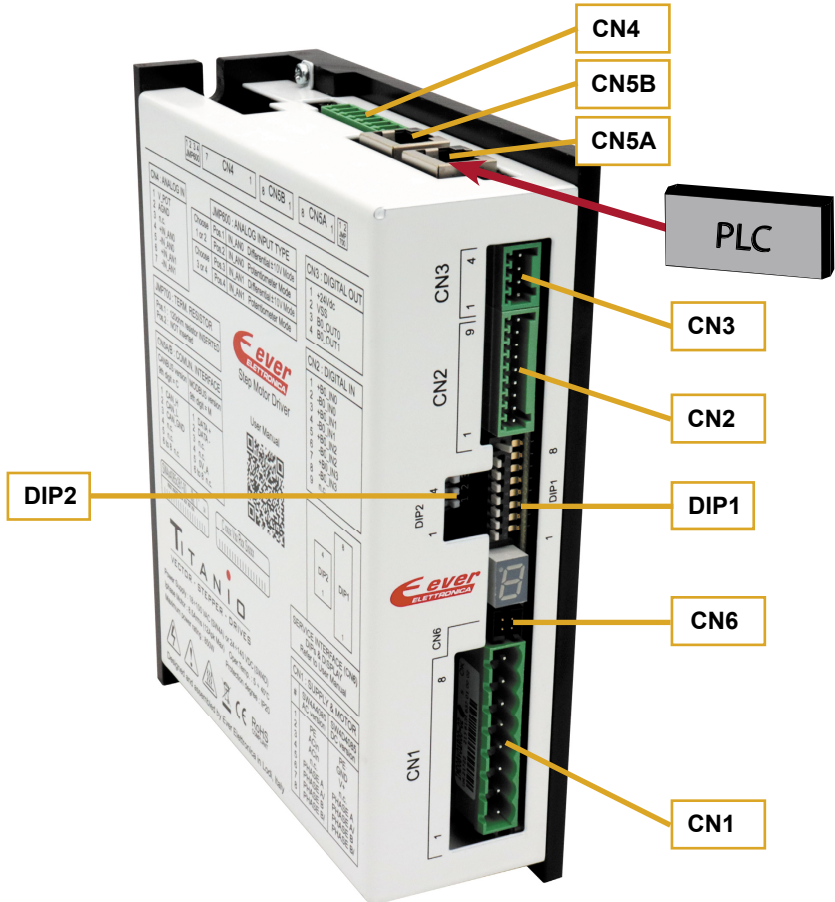

# System connection

## CN1: AC Power Supply & Motor (SW4A4085 version)

8 positions, pitch 5.08mm, PCB header connector

CN1.1	PE		Protective earth input
CN1.2	ACin	PWR_IN	<b>AC power supply input</b>
CN1.3	ACin	PWR_IN	
CN1.4	n.c.		Not connected
CN1.5	A	PWR_OUT	Motor output phase A
CN1.6	A /	PWR_OUT	Motor output phase A /
CN1.7	B	PWR_OUT	Motor output phase B
CN1.8	B /	PWR_OUT	Motor output phase B /

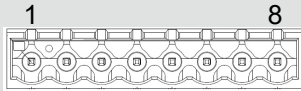

## CN2: Digital Inputs

9 positions, pitch 2.5mm, PCB header connector

CN2.1	+B0_IN0	DIG_IN	Digital input B0_IN0 positive side
CN2.2	-B0_IN0	DIG_IN	Digital input B0_IN0 negative side
CN2.3	+B0_IN1	DIG_IN	Digital input B0_IN1 positive side
CN2.4	-B0_IN1	DIG_IN	Digital input B0_IN1 negative side
CN2.5	+B0_IN2	DIG_IN	Digital input B0_IN2 positive side
CN2.6	-B0_IN2	DIG_IN	Digital input B0_IN2 negative side
CN2.7	+B0_IN3	DIG_IN	Digital input B0_IN3 positive side
CN2.8	-B0_IN3	DIG_IN	Digital input B0_IN3 negative side
CN2.9	n.c.		Not connected

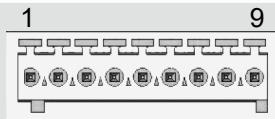

## CN3: Digital Outputs

4 positions, pitch 2.5mm, PCB header connector

CN3.1	+24 Vdc	PWR_IN	24 Vdc supply for digital output
CN3.2	VSS	PWR_IN	Negative input supply for digital output
CN3.3	B0_OUT0	DIG_OUT	PNP digital output B0_OUT0
CN3.4	B0_OUT1	DIG_OUT	PNP digital output B0_OUT1

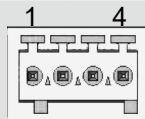

## CN4: Analog Inputs

7 positions, pitch 3.81mm, PCB header connector

CN4.1	V_POT	PWR_OUT	Voltage supply output for potentiometer
CN4.2	AGND	PWR_OUT	Output negative reference for potentiometer
CN4.3	n.c.		Not connected
CN4.4	+IN_AN0	AN_IN	Analog input 0 positive side
CN4.5	-IN_AN0	AN_IN	Analog input 0 negative side
CN4.6	+IN_AN1	AN_IN	Analog input 1 positive side
CN4.7	-IN_AN1	AN_IN	Analog input 1 negative side

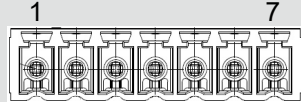

## CN6: Service SCI Interface

4 position, pitch 2.00mm, double row, PCB header connector

CN6.1	TX/RX	Transmit / Receive Line
CN6.2	DE/RE	Drive Enable Negated / Receive Enable
CN6.3	+5V	+5V power out
CN6.4	GND	GND power out

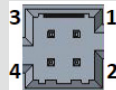

*This connection is only possible with hardware and software provided by Ever.*

## CN5A and CN5B: Canbus interface ("C" version)

RJ45, 8 positions shielded, PCB header connector

CN5.1	CAN_H	Digital I/O	Bus Line Domination HIGH
CN5.2	CAN_L	Digital I/O	Bus Line Domination LOW
CN5.3	CAN_GND	PWR_OUT	Signal Ground
CN5.4	n.c.		Not connected
CN5.5	n.c.		Not connected
CN5.6	n.c.		Not connected
CN5.7	n.c.		Not connected
CN5.8	n.c.		Not connected



## CN5A and CN5B: Modbus interface ("M" version)

RJ45, 8 positions shielded, PCB header connector

CN5.1	Data +	Digital I/O	Positive RS485 signal
CN5.2	Data -	Digital I/O	Negative RS485 signal
CN5.3	n.c.		Not connected
CN5.4	n.c.		Not connected
CN5.5	0V_A	PWR_OUT	Signal ground
CN5.6	n.c.		Not connected
CN5.7	n.c.		Not connected
CN5.8	n.c.		Not connected



# System connections

## JMP600 - Termination resistor

Pos. 1	IN_AN0	Differential +/- 10V mode	IN_AN0
Pos. 2	IN_AN0	Potentiometer mode ( <b>default</b> )	(choose 1 or 2)
Pos. 3	IN_AN1	Differential +/- 10V mode	IN_AN1
Pos. 4	IN_AN1	Potentiometer mode ( <b>default</b> )	(choose 1 or 2)

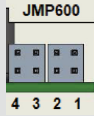

## JMP700 - Termination resistor

Position 1	120 ohm resistor INSERTED
Position 2	120 ohm resistor NOT inserted (default)

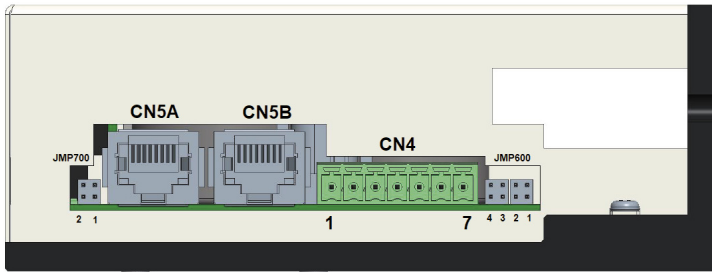
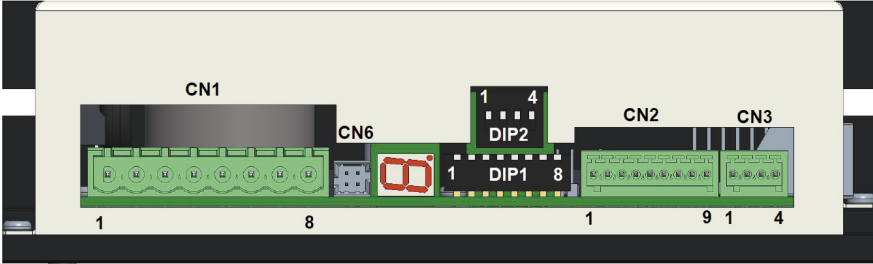
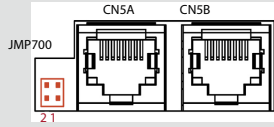

## Dip-Switches settings

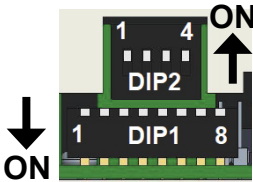

**NOTE :** the device reads the Dip-Switches only during the Power up.  
If it's necessary a setting change, shut down the system, change the settings and start up the system again to make the changes operating.

### Dip-switch allocation

DIP2				DIP1							
U1	U0	ID6	ID5	ID4	ID3	ID2	ID1	ID0	BD2	BD1	BD0
1			4	1							8

### Drive's baud rate selection

BD2	BD1	BD0	Modbus	CANOpen
OFF	OFF	OFF	115200	1 M
OFF	OFF	ON	57600 (default)	500 K (default)
OFF	ON	OFF	38400	250 K
OFF	ON	ON	19200	125 K
ON	OFF	OFF	9600	100 K
ON	OFF	ON	4800	50 K
ON	ON	OFF	2400	50 K
ON	ON	ON	1200	50 K

## Dip-Switches settings

### Drive's ID number selection

ID6	ID5	ID4	ID3	ID2	ID1	ID0	Node ID #
OFF	OFF	OFF	OFF	OFF	OFF	OFF	Not allowed
OFF	OFF	OFF	OFF	OFF	OFF	ON	1 (default)
OFF	OFF	OFF	OFF	OFF	ON	OFF	2
OFF	OFF	OFF	OFF	OFF	ON	ON	3
OFF	OFF	OFF	OFF	ON	OFF	OFF	4
OFF	OFF	OFF	OFF	ON	OFF	ON	5
OFF	OFF	OFF	OFF	ON	ON	OFF	6
OFF	OFF	OFF	OFF	ON	ON	ON	7
OFF	OFF	OFF	ON	OFF	OFF	OFF	8
OFF	OFF	OFF	ON	OFF	OFF	ON	9
OFF	OFF	OFF	ON	OFF	ON	OFF	10
OFF	OFF	OFF	ON	OFF	ON	ON	11
OFF	OFF	OFF	ON	ON	OFF	OFF	12
OFF	OFF	OFF	ON	ON	OFF	ON	13
OFF	OFF	OFF	ON	ON	ON	OFF	14
OFF	OFF	OFF	ON	ON	ON	ON	15
OFF	OFF	ON	OFF	OFF	OFF	OFF	16
OFF	OFF	ON	OFF	OFF	OFF	ON	17
OFF	OFF	ON	OFF	OFF	ON	OFF	18
OFF	OFF	ON	OFF	OFF	ON	ON	19
OFF	OFF	ON	OFF	ON	OFF	OFF	20
OFF	OFF	ON	OFF	ON	OFF	ON	21
OFF	OFF	ON	OFF	ON	ON	OFF	22
OFF	OFF	ON	OFF	ON	ON	ON	23
OFF	OFF	ON	ON	OFF	OFF	OFF	24
XX	XX	XX	XX	XX	XX	XX	...
ON	ON	ON	ON	ON	ON	ON	127

## Display Status

### Operational statuses and their signals

	Missing Operating System: no software application stored on drive
	Firmware update: Updating of new software in progress.
	Initialization: the drive executes the start-up procedure (a few seconds after the start-up procedure has begun).
	Correct functioning
	Voltage of DC bus near to the limit value (minimum or maximum)
	Drive temperature is near to the maximum value
	Warning: EEPROM near Write Overrun
	Warning: EEPROM near End of Life
	flashing Enable OFF, current zero
	flashing I <sub>nominal</sub> not computed
	Error: expired eePLC software trial
	Security intervention of watchdog
	Internal Software Error
	Missing calibration values
	Management EEPROM
	EEPROM fail
	Error: eePLC application error
	Error: EEPROM Write Overrun
	Error: Feature unavailable
	Open motor phases
	Over/under voltage;
	Over current on the motor output;
	Over temperature of the drive;
	Drive Over Power Protection and/or Current Regulation out of range
	eePLC User Protection (generated by setting bit #0 of eePLC_User_Settings)

## Service SCI connection



This connection is only possible with hardware and software provided by Ever.  
Kit code: SW4\_SERV00-SL or SW4-SERV00-EE.

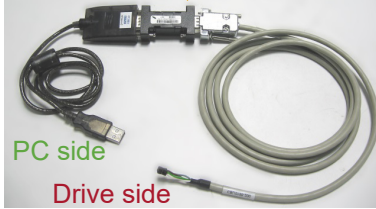

**ATTENTION!!!**  
Correct insertion direction of the CN6: TAB UP.

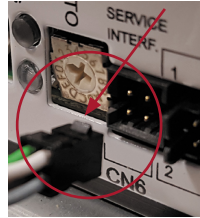

## Digital inputs connection



11-24 Vdc - PNP and NPN type (optoisolated)

Characteristics	MIN.	MAX.	Unit
Supply Voltage	11	24	Vdc
Inputs Frequency	---	200	kHz
Threshold switching voltage	4.5	---	Vdc
Input current	3.1	7.7	mA

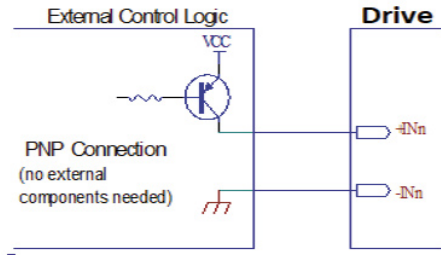
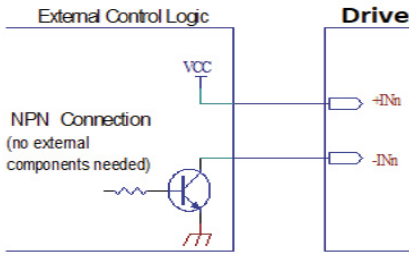

## Digital outputs connection



PNP with  $V_{OUTmax}=24Vdc$ ,  $I_{OUTmax}=100mA$ ,  $F_{max}=5kHz$

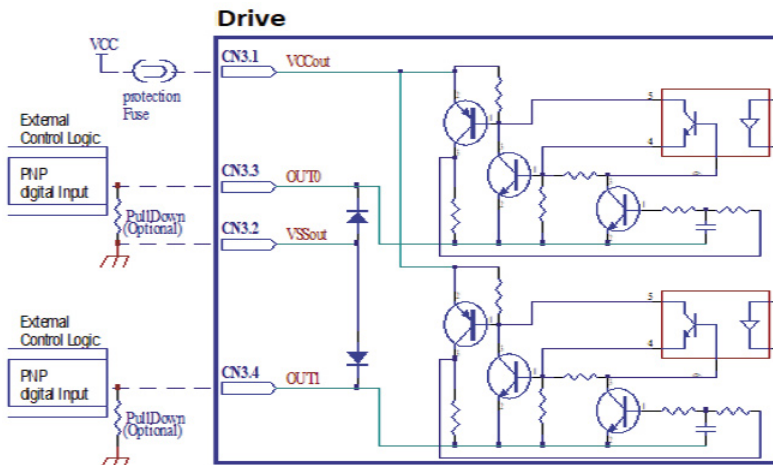

## Analog inputs connection



The type of the analog inputs depends from the connection of the JMP600 (see page 4)

### DIFFERENTIAL CONNECTION ( $\pm 10V$ or 0-10V)

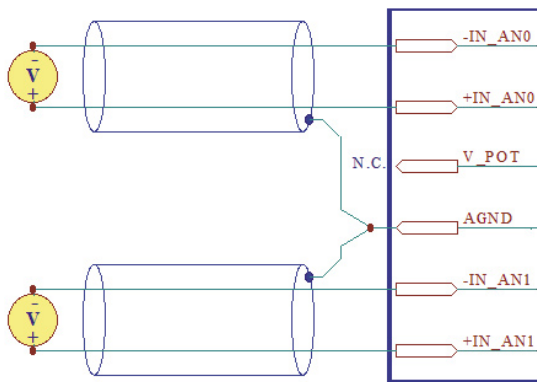

### POTENTIOMETER CONNECTION

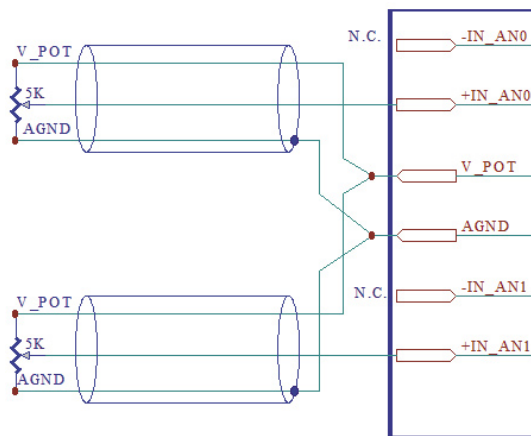

**The connection from an external reference and AGND should be preceded by a thorough risk analysis on the machine/circuit in which the drive will be installed.**

**AGND is internally in common with power ground, this is potentially dangerous. Take all necessary measures to avoid possible contacts in the final installation.**

## Mating connectors

Connector	Description
CN1	Phoenix 1757077 or Wurth 691 351 500 008
CN2	Phoenix 1881396
CN3	Phoenix 1881341
CN4	Phoenix 1803620 or Wurth 691 361 300 007
CN5A/CN5B	RJ45, 8 positions

## Section of the cables

Function	Cable	
	Minimum	Maximum
Power supply, Motor output and PE	0.50 mm <sup>2</sup> (AWG20)	2.50 mm <sup>2</sup> (AWG12)
Communication interfaces	0.25 mm <sup>2</sup> (AWG23) CABbus CIA-CANOpen	
Digital Inputs / Outputs and STO	0.14 mm <sup>2</sup> (AWG26)	0.50 mm <sup>2</sup> (AWG20)
Analog Inputs	0.14 mm <sup>2</sup> (AWG26)	1.50 mm <sup>2</sup> (AWG16)

## Verify the installation

- Check all connection: power supply and inputs/outputs.
- Make sure all settings right for the application.
- Make sure the power supply is suitable for the drive.
- If possible, remove the load from the motor shaft to avoid that wrong movements cause damage.
- Enable the current to the motor and verify the applied torque.
- Enable a movement of some steps and verify if the rotation direction is the desired one.
- Disconnect the power supply, connect the load on the motor and check the full functionality.

## Drive's fault analysis



**When any of the following situations occur, the drive is placed in a fault condition.**

DEFECT	CAUSE	ACTION
Intervention of the thermal protection.	Can be caused by a heavy working cycle or a high current in the motor.	Improve the drive cooling by natural or fan air flow. Consider to use a motor with a higher torque vs current rating.
Intervention of the current protection.	Short circuit on the motor powering stage(s) of the drive.	Check motor windings and cables to remove the short circuits replacing faulty cables or motor if necessary.
Intervention of the over/under voltage protection.	Supply voltage out of range	Check the value for the supply voltage
Open phase motor protection.	Motor windings to drive not proper connection.	Check motor cables and connections to the drive.



**When one of the following situations occur, the drive doesn't function correctly and it is reported an error.**

DEFECT	CAUSE	ACTION
Noisy motor movement with vibrations.	Can be caused by a lack of power supply to a phase of the motor or a poor regulation of the winding currents.	Check the cables and connections of the motor and/or change the motor speed to avoid a resonance region.
The external fuse on the power supply of the drive is burned.	Can be caused by a wrong connection of the power supply.	Connect the power supply correctly and replace the fuse.
At high speed, the motor torque is not enough.	Can be due to a "self-limitation" of motor current and torque.	Increase the motor current (always within the limits), increase the supply voltage, change motor connection from series to parallel.

### Ever Motion Solutions

Via del Commercio, 2/4 - 9/11

Loc. San Grato Z. I

26900 - L O D I - Italy

Phone +39 0371 412318 - Fax +39 0371 412367

email: infoever@everelettronica.it

web: www.everelettronica.it

